

# Aerophone mini

## Owner's Manual

### Contents

<b>Panel Descriptions</b> .....	<b>2</b>
<b>Before You Play</b> .....	<b>4</b>
Selecting the Power Source .....	4
Turning the Aerophone mini On .....	5
Wrapping the Band .....	5
Changing the Sound Settings .....	6
Provide As Necessary.....	8
Connecting Your Headphones or External Speakers .....	8
Returning to the Factory Settings (Factory Reset).....	8
<b>Playing</b> .....	<b>9</b>
Attaching the Neck Strap .....	9
Holding the Aerophone mini.....	9
How to Make Sound .....	10
Using the Octave keys.....	10
Pressing the Performance Keys .....	11
<b>Using the Bluetooth Functionality</b> .....	<b>12</b>
Here's What You Can Do .....	12
Connection Procedure .....	12
Performing Along with Music Played by Your Smartphone .....	12
Using the Aerophone mini with an App.....	13
If You Can't Connect via Bluetooth ....	14
<b>Caring for the Aerophone mini</b> .....	<b>15</b>
<b>USING THE UNIT SAFELY</b> .....	<b>16</b>
<b>IMPORTANT NOTES</b> .....	<b>18</b>

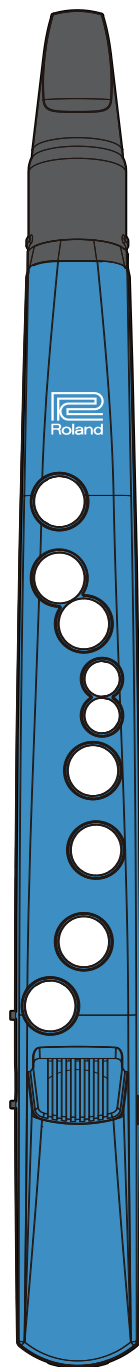

English

日本語

Deutsch

Français

Italiano

Español

Português

Nederlands

\* Before using this unit, carefully read "USING THE UNIT SAFELY" (p. 16) and "IMPORTANT NOTES" (p. 18). After reading, keep the document(s) where it will be available for immediate reference.

# Panel Descriptions

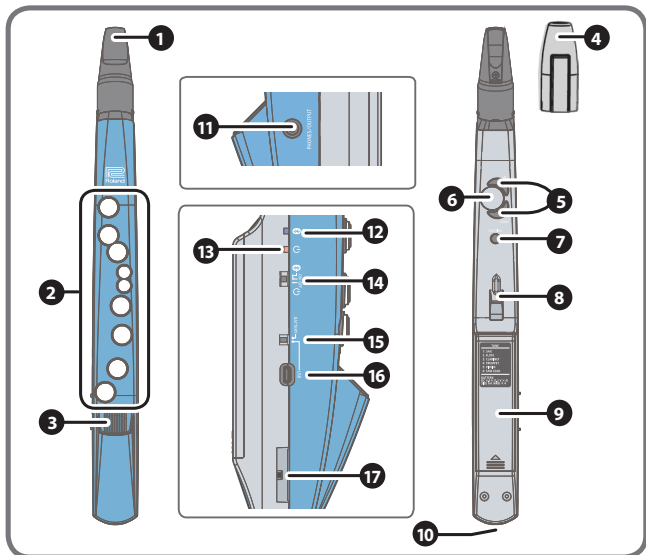

## 1 Mouthpiece

A mouthpiece that is constructed as a single unit with the reed.

## 2 Performance keys

These keys are used for performance. You can play using fingering that's based on that of a recorder.

➔ "Pressing the Performance Keys" (p. 11)

## 3 Built-in speakers

## 4 Mouthpiece Cap

Protects the mouthpiece. When you're not playing, leave the mouthpiece cap attached. Taking care that it does not touch the reed, press it on until you hear it click into place.

## 5 Octave keys (UP/DOWN)

Switch the octave. You can use these to raise or lower the pitch by one octave. Operate them using the left-hand thumb.

You also use these keys to select the value of a sound setting.

➔ "Using the Octave keys" (p. 10)

➔ "Changing the Sound Settings" (p. 6)

## 6 Thumb rest

Place your left thumb here.

➔ "Holding the Aerophone mini" (p. 9)

## 7 [FUNCTION] button

Use this button to specify various settings such as the sound, volume, and transposition.

➔ "Changing the Sound Settings" (p. 6)

**8 Thumb hook/Strap ring**

Place your right thumb under the hook. You can attach a neck strap to the strap ring.

➔ “Holding the Aerophone mini” (p. 9)

➔ “Attaching the Neck Strap” (p. 9)

**9 Battery case**

If you are using the Aerophone mini on batteries, insert four Ni-MH batteries (AA).

➔ “Selecting the Power Source” (p. 4)

\* Please note that alkaline batteries and zinc-carbon batteries cannot be used.

**10 Water drain**

Drops of water will exit here. Wipe them off with a soft cloth.

**11 PHONES/OUTPUT jack**

Connect this jack to your headphones or external speakers.

➔ “Connecting Your Headphones or External Speakers” (p. 8)

**12 Bluetooth LED (blue)**

The LED indicates the Bluetooth connection status.

Lit	Connected via Bluetooth
Blinking	Waiting to connect via Bluetooth
Unlit	Bluetooth off

**13 Power LED (orange)**

The LED indicates whether the power is on/off and the amount remaining in the batteries.

Lit	Power on
Blinking	Batteries are low
Unlit	Power off

**14 [⏻] switch**

This switches between power off, power on, and power on + Bluetooth on.

➔ “Turning the Aerophone mini On” (p. 5)

**15 Power Select Switch**

This selects the Aerophone mini’s power source (batteries or USB AC adaptor).

➔ “Selecting the Power Source” (p. 4)

**16 USB Port**

If you are powering the Aerophone mini from a USB AC adaptor, connect the included USB cable.

➔ “Selecting the Power Source” (p. 4)

\* Do not use any cable other than the included USB cables.

**17 Cord hook**

When using a USB cable, use this cord hook to secure it.

➔ “Selecting the Power Source” (p. 4)

English

日本語

Deutsch

Français

Italiano

Español

Português

Nederlands

# Before You Play

## Step 1 Selecting the Power Source

The Aerophone mini can be powered by batteries or by a USB AC adaptor.

### When using batteries

This allows approximately 10 hours of playing.

#### 1. Insert four Ni-MH (AA) batteries.

\* Please note that alkaline batteries and zinc-carbon batteries cannot be used.

#### 2. Set the power select switch to "BATTERY"

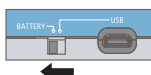

- \* When turning the unit over, be careful so as to protect the buttons and knobs from damage. Also, handle the unit carefully; do not drop it.
- \* Battery life can vary depending on the specifications of the batteries, capacity of the batteries, and the conditions of use.
- \* When the batteries run low, the power LED (orange) blinks.
- \* If you handle batteries improperly, you risk explosion fluid leakage. Make sure that you carefully observe all of the items related to batteries that are listed in "USING THE UNIT SAFELY" (p. 16) and "IMPORTANT NOTES" (p. 18).

### When using USB AC adaptor

You can play without being concerned about how much battery power you have left.

#### 1. Connect a USB cable (included) and USB AC adaptor (sold separately) to the Aerophone mini's USB port.

- \* A USB AC adaptor is not included. Use a charger such as intended for a smartphone or tablet.
- \* This unit cannot charge batteries that are installed in it, even if it is connected by a USB cable to a USB AC adaptor that's plugged into an AC outlet.

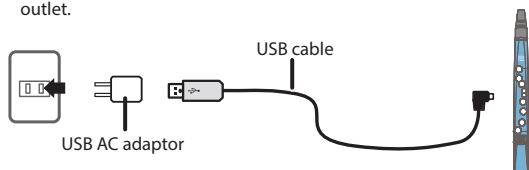

#### 2. Use the cord hook to secure the USB cable.

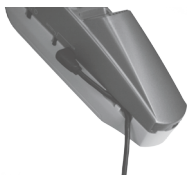

### 3. Set the power select switch to "USB."

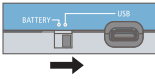

- \* Use only the included power supply USB cable. When connecting or disconnecting the cable, grasp the plug itself; do not pull the cable.
- \* Handle USB cables with care. If saliva drips down the USB cable and reaches the interior of the USB AC adaptor, malfunctions or electrical shock might occur.

## Step 2 Turning the Aerophone mini On

Set the [⏻] switch to "ON." If you want to use Bluetooth functionality, set it to the [📶] position.

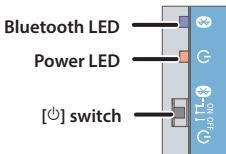

#### NOTE

The sensitivity of the mouthpiece is automatically adjusted when you turn on the power (this unit takes about seven seconds for the system to start). For this reason, don't bite or touch the mouthpiece while turning on the [⏻] switch.

- \* The power LED indicates whether power is on or off.
- \* When you turn the power switch "OFF," the power LED blinks and the shutdown process occurs. Do not remove the batteries or disconnect the USB AC adaptor until the LED goes dark.
- \* The power to this unit will be turned off automatically after a predetermined amount of time has passed since it was last used for playing music, or its buttons or controls were operated (Auto Off function). To prevent the power from turning off automatically, make settings in the app to disable the Auto Off function. To turn the power on again, set the [⏻] switch to the "OFF" position, and then move it back to the "ON" position.

## Step 3 Wrapping the Band

If you continue playing for an extended time, saliva from your mouth might drip down across the instrument and enter the interior from around the [⏻] switch or any keys. When playing the instrument, wrap the included band around it as shown in the illustration.

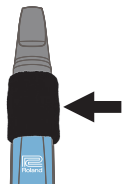

English

日本語

Deutsch

Français

Italiano

Español

Português

Nederlands

## Step 4 Changing the Sound Settings

1. While holding down the [FUNCTION] button, press the performance key of the item you want to set, pressing it the appropriate number of times for the setting you want.

Each time you press the performance key, the setting value increases, and you hear a number of beeps corresponding to the selected value.

Example: If you want to change the "1: SAX" tone to "5: VIOLIN," hold down the [FUNCTION] button and press the [TONE] button four times in succession.

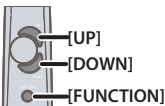
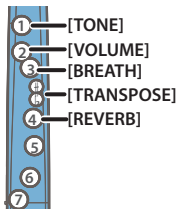

### MEMO

You can also change the value of a setting by holding down the [FUNCTION] button and using the [UP][DOWN] buttons.

### Tone

### Performance key 1 [TONE]

#### Tone List

Value	Tone Name
1	SAX
2	FLUTE
3	CLARINET
4	TRUMPET
5	VIOLIN
6	SAW LEAD (Synthesizer sounds)

\* The tone names are also listed on the battery cover of the Aerophone mini unit.

### Volume

### Performance key 2 [VOLUME]

This adjusts the volume of the Aerophone mini unit. This affects the volume of the built-in speaker and the volume from the device that's connected to the PHONES/OUTPUT jack.

Value	Explanation
1-5	Higher values are a louder volume; lower values are a lower volume.

## How your breath affects the sound Performance key 3 [BREATH]

Specifies how the sound responds to the force of your breath.

Value	Explanation
1 Light2	We recommend these settings if you're a beginning wind instrument player, or if you're not confident of your lung capacity. Fortissimo (ff) can be produced even by blowing relatively softly.
2 Light1	This setting is the closest to the response of an actual wind instrument.
3 Middle	We recommend these settings for wind instrument players.
4 Heavy1	Fortissimo (ff) is produced only when you blow quite strongly.
5 Heavy2	

English

日本語

## Reverberation Performance key 4 [REVERB]

This adjusts the depth of reverberation.

Value	Explanation
1-5	Higher values produce deeper reverberation; lower values produce shallower reverberation (A value of 1 is no reverberation).

Deutsch

Français

## Selecting the key Performance key # or ♭ [TRANPOSE]

You can transpose in semitone steps. For example if you're reading music written for alto sax, set this to "+3" (E♭).

### MEMO

If you press [UP] and [DOWN] simultaneously, the transpose setting is reset to "C."

Italiano

Español

Português

Nederlands

Value	Key	Explanation
+6	F#	You hear a short, high-pitched "beep" for a number of times corresponding to the value of the setting.
+5	F	
+4	E	
+3	E♭	
+2	D	
+1	C#	
0	C	You hear a medium-pitched "beep" twice.
-1	B	You hear a long, low-pitched "beep" for a number of times corresponding to the value of the setting.
-2	B♭	
-3	A	
-4	A♭	
-5	G	

## Step 5 Provide As Necessary

### Connecting Your Headphones or External Speakers

If you want to connect headphones or an external speaker, connect them to the PHONES/OUTPUT jack.

- \* To prevent malfunction and equipment failure, always turn down the volume, and turn off all the units before making any connections.

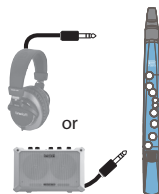

#### Headphones

Since sound is not produced by the built-in speaker of the Aerophone mini, this is convenient for night-time practice.

#### External speakers

Since this allows high volume to be produced, it is convenient when you're performing live for a large number of people.

### Returning to the Factory Settings (Factory Reset)

Here's how to return the Aerophone mini to its factory-set state.

- 1. While holding down both of the buttons [UP] and [DOWN], turn the [ϕ] switch "ON."**  
A series of short "beeps" is heard, asking you to confirm the operation.
- 2. Press the [FUNCTION] button.**  
A long "beep" is heard, and the settings return to the factory-set state.
- 3. Turn the power off, and then on again.**  
This completes the factory reset.



# Playing

## Step 1 Attaching the Neck Strap

Attach the hook of the strap to the strap ring of the Aerophone mini.



## Step 2 Holding the Aerophone mini

1. Hold it as shown in the illustration.

\* If saliva runs down during performance, use a dry cloth to wipe it off diligently.

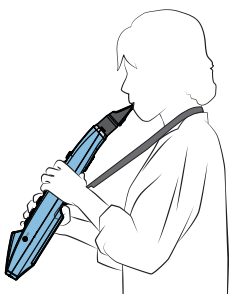

2. Place your left thumb on the thumb rest, and place your right thumb under the thumb hook.

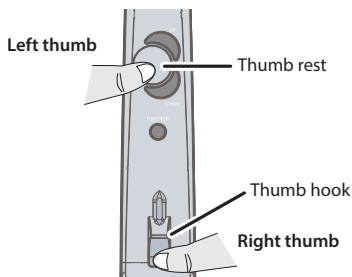

English

日本語

Deutsch

Français

Italiano

Español

Português

Nederlands

### Step 3 Using the Octave keys

Use your left thumb to switch the octave.  
You can raise or lower the pitch by one octave.

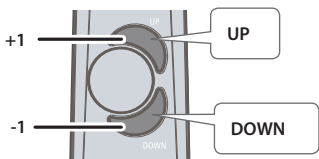

### Step 5 How to Make Sound

To begin, let's try playing C D E F G A B C.  
Take a deep breath, and blow as through you're filling the entire instrument.



C

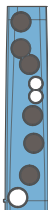

D



E



F



G

➔ For details on fingering, refer to "Fingering Chart" at the end of this manual.

## Step 4 Pressing the Performance Keys

Perform using the "C D E F G A B C" fingering of a standard recorder in conjunction with the performance keys [♯] [♭].

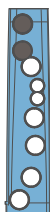
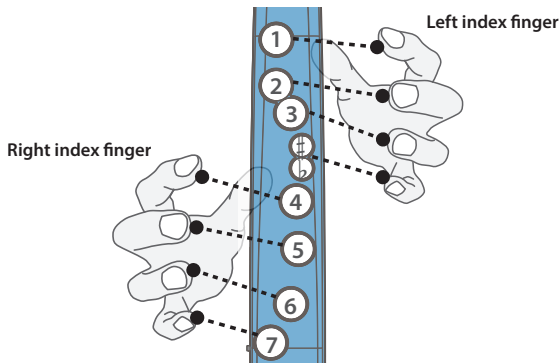

A



B



C

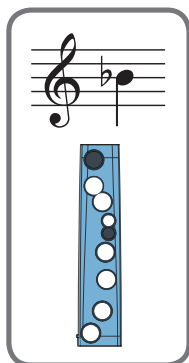

\* To produce "♯" or "♭" hold down a "C D E F G A B C" performance key and press the [♯] or [♭] key.

English

日本語

Deutsch

Français

Italiano

Español

Português

Nederlands

# Using the Bluetooth Functionality

## Here's What You Can Do

You can use the Aerophone mini along with a mobile device such as a smartphone or tablet (subsequently referred to as a "smartphone").



- You can use the speaker of the Aerophone mini to hear music played back from your smartphone. You can also perform along with the song playback.
  - **Performing along with music played by your smartphone**
- You can use the "Aerophone mini Plus" app to make detailed settings for the Aerophone mini, and use tones that are available only in the app.
  - \* The "Aerophone mini Plus" app supports iOS and Android products.
  - **Using the Aerophone mini with an app**

## Connection Procedure

### Pairing

To connect wirelessly via Bluetooth, you must first perform "pairing" so that the Aerophone mini is connected to your smartphone in a one-to-one relationship. "Pairing" is the procedure of registering (mutually authenticating) your smartphone with Aerophone mini.



## Performing Along with Music Played by Your Smartphone

Make settings for performing on the Aerophone mini as appropriate for the music that you want to play back from your smartphone.

1. **Place the smartphone near the Aerophone mini.**
2. **Set the Aerophone mini's [⏏] switch to the "0."**  
The Bluetooth LED blinks.
3. **Hold down the [FUNCTION] button and long-press performance key 5.**  
The Aerophone mini is now ready to begin pairing.  
When pairing starts, you'll hear a "beep" twice.

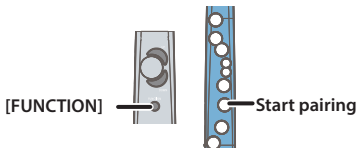

4. **In your smartphone's settings, turn Bluetooth on.**

Example screen on an iOS device



## 5. Tap “AE-01 Audio” that is shown in the Bluetooth device screen of your smartphone.

Aerophone mini is paired with the smartphone. When the screen of the smartphone shows as follows, pairing is complete.

### iOS device

“MY DEVICES” → “AE-01 Audio Connected”

### Android device

“Paired devices” → “AE-01 Audio”

\* To disconnect, either set the Aerophone mini’s [⏏] switch to other than the “Ⓚ” position or turn the smartphone’s Bluetooth function off.

## 6. On your smartphone, use a music app to play back a song.

The sound is heard from the speaker of the Aerophone mini.

\* The playback volume cannot be adjusted from the Aerophone mini itself. Use your smartphone to adjust the volume.

## Using the Aerophone mini with an App

Make connections for using the “Aerophone mini Plus” app.

### 1. Install the app “Aerophone mini Plus” on your smartphone.

Download the app from the App Store if you have an iOS device, or from Google Play if you have an Android device.

\* Download the app when your smartphone has a connection to the internet. The download won’t complete unless you have an internet connection.

### 2. Place the smartphone on which the app is installed near the Aerophone mini.

### 3. Set the Aerophone mini’s [⏏] switch to the “Ⓚ” position.

The Bluetooth LED blinks.

### 4. In your smartphone’s settings, turn Bluetooth on.

#### NOTE

Even if the model name “AE-01” is shown in the “DEVICES” list (iOS) or “Available devices” list (Android), don’t tap it.

### 5. Start the app, and perform pairing as directed by the screen.

When the Bluetooth LED changes to steadily lit, connection is complete.

\* Tones in the app are heard from the smartphone. If you want to play the app’s sound engine, set the Aerophone mini’s volume to the minimum (p. 6). If the volume is raised, you’ll hear the app’s sound engine simultaneously with the sound of the Aerophone mini.

\* When tones in the app are heard from the smartphone, you might notice that the sound is delayed, but this is not a malfunction.

\* When using the app, you can’t use the function that lets you hear music played back by the smartphone. If you connect the app when an audio connection is active, the audio connection is ended and the app is connected.

### If You Can't Connect via Bluetooth

If pairing between the Aerophone mini and your smartphone is unsuccessful, check the following.

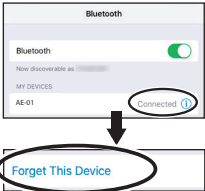
Items to check / Problem	Action
Is the [⓪] switch set to the "ⓧ" position?	Set the [⓪] switch to the "ⓧ" position.
In the settings of your smartphone, is the Bluetooth functionality turned "on"?	In your smartphone's settings, turn Bluetooth on. * If it is "on" but you still can't connect, try turning it "off" and then "on" again; this might allow connection to occur.
Can't connect with the "Aerophone mini Plus" app	If you're using Android 6.0 or later, turn on Android's location information.
	Temporarily end the smartphone's Bluetooth connection, and then re-do the connection settings. <b>1. Close all apps on the smartphone.</b> <b>2. If paired, use the smartphone's settings to end the connection, and turn the Bluetooth switch off.</b>  <b>3. Repeat the procedure from step 1 of "Using the Aerophone mini with an App" (p. 13).</b>

If you've checked the points listed above but are still unable to solve the problem, refer to the support page of the Roland website or contact your dealer.

<http://www.roland.com/support/>

# Caring for the Aerophone mini

1. If the mouthpiece becomes soiled from playing, remove the mouthpiece, wash it with water, and use a soft cloth to dry off any water droplets.



2. Insert the mouthpiece all the way until the concave and convex portions align.

\* Take care that the front and back of the mouthpiece are oriented correctly. If you insert it in the wrong orientation, it might become impossible to remove.



## NOTE

- Take care not to hurt your hand on the screw that's inside the mouthpiece.
  - Applying commercially available recorder cream makes attachment and removal easier.
3. Lean the Aerophone mini against a wall or other vertical surface, so that any saliva inside the instrument can drain out. When you lean the instrument against a wall or other vertical surface with the mouthpiece upward, any saliva inside will exit from the water drain (p. 3). Wipe it off with a soft cloth.

English

日本語

Deutsch

Français

Italiano

Español



Português

Nederlands







# USING THE UNIT SAFELY

## INSTRUCTIONS FOR THE PREVENTION OF FIRE, ELECTRIC SHOCK, OR INJURY TO PERSONS

About  WARNING and  CAUTION Notices

 <b>WARNING</b>	Used for instructions intended to alert the user to the risk of death or severe injury should the unit be used improperly.
 <b>CAUTION</b>	Used for instructions intended to alert the user to the risk of injury or material damage should the unit be used improperly. * Material damage refers to damage or other adverse effects caused with respect to the home and all its furnishings, as well to domestic animals or pets.

About the Symbols

	The  symbol alerts the user to important instructions or warnings. The specific meaning of the symbol is determined by the design contained within the triangle. In the case of the symbol at left, it is used for general cautions, warnings, or alerts to danger.
	The  symbol alerts the user to items that must never be carried out (are forbidden). The specific thing that must not be done is indicated by the design contained within the circle. In the case of the symbol at left, it means that the unit must never be disassembled.
	The  symbol alerts the user to things that must be carried out. The specific thing that must be done is indicated by the design contained within the circle. In the case of the symbol at left, it means that the power-cord plug must be unplugged from the outlet.

### ALWAYS OBSERVE THE FOLLOWING

#### WARNING

When using the strap, take care that it does not become wound around your neck.



#### Concerning the Auto Off function

The power to this unit will be turned off automatically after a predetermined amount of time has passed since it was last used for playing music, or its buttons or controls were operated (Auto Off function). To prevent the power from turning off automatically, make settings in the app to disable the Auto Off function.



#### Do not disassemble or modify by yourself

Do not carry out anything unless you are instructed to do so in the owner's manual. Otherwise, you risk causing malfunction.



#### Do not repair or replace parts by yourself

Be sure to contact your dealer, a Roland service center, or an official Roland dealer.



For a list of Roland service centers and official Roland dealers, refer to the Roland website.

#### Do not use or store in the following types of locations

- Subject to temperature extremes (e.g., direct sunlight in an enclosed vehicle, near a heating duct, on top of heat-generating equipment); or are
- Damp (e.g., baths, washrooms, on wet floors); or are
- Exposed to steam or smoke; or are
- Subject to salt exposure; or are
- Exposed to rain; or are
- Dusty or sandy; or are
- Subject to high levels of vibration and shakiness; or are
- Placed in a poorly ventilated location.



#### WARNING

#### Do not place in an unstable location

Otherwise, you risk injury as the result of the unit toppling over or dropping down.



#### Avoid extended use at high volume

Use of the unit at high volume for extended periods of time may cause hearing loss. If you ever experience any hearing loss or ringing in the ears, you should immediately stop using the unit and consult a specialized physician.



#### Do not allow foreign objects or liquids to enter unit; never place containers with liquid on unit

Do not place containers containing liquid (e.g., flower vases) on this product. Never allow foreign objects (e.g., flammable objects, coins, wires) or liquids (e.g., water or juice) to enter this product. Doing so may cause short circuits, faulty operation, or other malfunctions.



#### Turn off the unit if an abnormality or malfunction occurs

In the following cases, immediately turn off the power and contact your dealer, a Roland service center, or an official Roland dealer for service.



- If smoke or unusual odor occurs; or
- Objects have fallen into, or liquid has been spilled onto the unit; or
- The unit has been exposed to rain (or otherwise has become wet); or
- The unit does not appear to operate normally or exhibits a marked change in performance.

For a list of Roland service centers and official Roland dealers, refer to the Roland website.

#### Be cautious to protect children from injury

Always make sure that an adult is on hand to provide supervision and guidance when using the unit in places where children are present, or when a child will be using the unit.





**⚠ WARNING**

**Do not drop or subject to strong impact**

Otherwise, you risk causing damage or malfunction.



**Handle batteries carefully**

If used improperly, you risk the dangers of fluid leakage, overheating, combustion, explosion, etc. Carefully observe the following:

- Do not heat, disassemble, or toss them into a fire or water.
- Do not expose them to sunlight, flame, or any other source of extreme heat.
- Do not attempt to charge a dry cell battery.
- When using a rechargeable battery and a charger, make sure to use only the combination of rechargeable battery and charger that has been specified by the battery manufacturer. Also, be sure to read all of the precautions that were supplied with the rechargeable battery and charger, and abide by them when using the battery/charger.



**Route all power cords and cables in such a way as to prevent them from getting entangled**

Injury could result if someone were to trip on a cable and cause the unit to fall or topple.



**Avoid climbing on top of the unit, or placing heavy objects on it**

Otherwise, you risk injury as the result of the unit toppling over or dropping down.



**Disconnect all cords/cables before moving the unit**

Damage or malfunction may result if you fail to disconnect all cables before moving the unit.



**⚠ WARNING**

**Handle batteries carefully**

If used improperly, batteries may explode or leak and cause damage or injury. In the interest of safety, please read and observe the following precautions.

- Carefully follow the installation instructions for batteries, and make sure you observe the correct polarity.
- Avoid using new batteries together with used ones. In addition, avoid mixing different types of batteries.
- Remove the batteries whenever the unit is to remain unused for an extended period of time.
- Whenever the unit is to remain unused for an extended period of time, make a backup of any important data, and then remove the batteries.
- Never keep batteries together with metallic objects such as ballpoint pens, necklaces, hairpins, etc.
- Used batteries must be disposed of in compliance with whatever regulations for their safe disposal that may be observed in the region in which you live.



**Handle leaking batteries carefully**

- Do not touch the liquid with your bare hands.
- If any of the leaking fluid gets into your eyes, the loss of vision may result. Do not rub your eyes; use clean water to flush them thoroughly. Then, promptly see a doctor.
- Burning of the skin or dermatitis may result if fluid has gotten onto your skin or clothing. Use clean water to flush affected areas thoroughly; then, promptly see a doctor.
- Using a soft cloth, carefully wipe any remaining fluid from the inside of the battery compartment. Then, install new batteries.



**Product Serial Number**

This unit's serial number is listed inside the battery compartment.

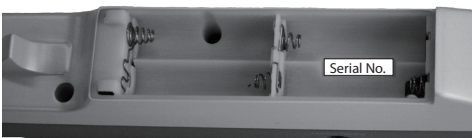

English

日本語

Deutsch

Français

Italiano

Español

Português

Nederlands

# IMPORTANT NOTES

## Power Supply: Use of Batteries

- Before installing/removing batteries, make sure to turn off the power to this unit and disconnect all connections to other devices.

If operating this unit on batteries, please use Ni-MH batteries.

## Placement

- Using the unit near power amplifiers (or other equipment containing large power transformers) may induce hum. To alleviate the problem, change the orientation of this unit; or move it farther away from the source of interference.
- This unit may interfere with radio and television reception. Do not use this unit in the vicinity of such receivers.
- Noise may be produced if wireless communications devices, such as cell phones, are operated in the vicinity of this unit. Such noise could occur when receiving or initiating a call, or while conversing. Should you experience such problems, you should relocate such wireless devices so they are at a greater distance from this unit, or switch them off.
- When moved from one location to another where the temperature and/or humidity is very different, water droplets (condensation) may form inside the unit. Damage or malfunction may result if you attempt to use the unit in this condition. Therefore, before using the unit, you must allow it to stand for several hours, until the condensation has completely evaporated.
- Do not place containers or anything else containing liquid on top of this unit. Also, whenever any liquid has been spilled on the surface of this unit, be sure to promptly wipe it away using a soft, dry cloth.

## Maintenance

- Never use benzine, thinners, alcohol or solvents of any kind, to avoid the possibility of discoloration and/or deformation.

## Repairs and Data

- Before sending the unit away for repairs, be sure to make a backup of the data stored within it; or you may prefer to write down the needed information. Although we will do our utmost to preserve the data stored in your unit when we carry out repairs, in some cases, such as when the memory section is physically damaged, restoration of the stored content may be impossible. Roland assumes no liability concerning the restoration of any stored content that has been lost.

## Additional Precautions

- Any data stored within the unit can be lost as the result of equipment failure, incorrect operation, etc. To protect yourself against the irretrievable loss of data, try to make a habit of creating regular backups of the data you've stored in the unit.
- Roland assumes no liability concerning the restoration of any stored content that has been lost.
- Use a reasonable amount of care when using the unit's buttons, sliders, or other controls; and when using its jacks and connectors. Rough handling can lead to malfunctions.
- When disconnecting all cables, grasp the connector itself—never pull on the cable. This way you will avoid causing shorts, or damage to the cable's internal elements.
- To avoid disturbing others nearby, try to keep the unit's volume at reasonable levels.

## Caution Regarding Radio Frequency Emissions

- The following actions may subject you to penalty of law.
  - Disassembling or modifying this device.
  - Removing the certification label affixed to the back of this device.
  - Using this device in a country other than where it was purchased
- Keep this product at least 22 cm (8-11/16 inches) away from a location where a cardiac pacemaker is installed. There is a risk that it could affect the operation of a pacemaker.

**Intellectual Property Right**

- The copyright of content in this product (the sound waveform data, style data, accompaniment patterns, phrase data, audio loops and image data) is reserved by Roland Corporation.
- Purchasers of this product are permitted to utilize said content (except song data such as Demo Songs) for the creating, performing, recording and distributing original musical works.
- Purchasers of this product are NOT permitted to extract said content in original or modified form, for the purpose of distributing recorded medium of said content or making them available on a computer network.
- The **Bluetooth®** word mark and logos are registered trademarks owned by Bluetooth SIG, Inc. and any use of such marks by Roland is under license.

- Roland is either registered a trademark or a trademark of Roland Corporation in the United States and/or other countries.
- Company names and product names appearing in this document are registered trademarks or trademarks of their respective owners.

English

日本語

Deutsch

Français

Italiano

Español

Português

Nederlands

**Main Specifications**

**Roland Aerophone mini (AE-01): Digital Wind Instrument**

<b>Power Supply</b>	USB AC adaptor (sold separately) Ni-MH battery (AA, HR6) (sold separately) x 4
<b>Current Draw</b>	400 mA
<b>Battery life for continuous use</b>	Ni-MH battery: approximately 10 hours (When using batteries having a capacity of 1,900 mAh.) * differs depending on the conditions of use * Carbon-zinc or alkaline batteries cannot be used
<b>Bluetooth</b>	Bluetooth Ver 4.2 Profile Support: A2DP (Audio), GATT (MIDI over Bluetooth Low Energy) Codec: SBC (Support to the content protection of the SCMS-T method)
<b>Dimensions</b>	43 (W) x 76 (D) x 444 (H) mm 1-3/4 (W) x 3 (D) x 17-1/2 (H) inches
<b>Weight (including batteries)</b>	500 g, 1 lb 2 oz
<b>Accessories</b>	Owner's Manual, Mouthpiece cap, Neck strap, Band, USB cable (Power (Type A))
<b>Options (sold separately)</b>	Replacement Mouthpiece (OP-AE01MP, OP-AE05MPH)

\* This document explains the specifications of the product at the time that the document was issued. For the latest information, refer to the Roland website.

# Fingering Chart / 運指表

B3                      C4                      C#4/D $\flat$ 4

This section shows the fingering for notes B3, C4, and C#4/D4. Each note is represented by a treble clef staff with a single note and a corresponding vertical fingering diagram. The diagrams show finger placement on strings 1 through 5, with black circles for fretted notes and white circles for natural notes.

- B3:** Treble clef, one flat. Fingering: 1 (index), 2 (middle), 3 (ring), 4 (pinky).
- C4:** Treble clef, one flat. Fingering: 1 (index), 2 (middle), 3 (ring), 4 (pinky).
- C#4/D $\flat$ 4:** Treble clef, one sharp and one flat. Fingering: 1 (index), 2 (middle), 3 (ring), 4 (pinky).

D4                      D#4/E $\flat$ 4                      E4

This section shows the fingering for notes D4, D#4/E4, and E4. Each note is represented by a treble clef staff with a single note and a corresponding vertical fingering diagram.

- D4:** Treble clef, one flat. Fingering: 1 (index), 2 (middle), 3 (ring), 4 (pinky).
- D#4/E $\flat$ 4:** Treble clef, one sharp and one flat. Fingering: 1 (index), 2 (middle), 3 (ring), 4 (pinky).
- E4:** Treble clef, one flat. Fingering: 1 (index), 2 (middle), 3 (ring), 4 (pinky).

F4                      F#4/G $\flat$ 4

This section shows the fingering for notes F4 and F#4/G4. Each note is represented by a treble clef staff with a single note and a corresponding vertical fingering diagram.

- F4:** Treble clef, one flat. Fingering: 1 (index), 2 (middle), 3 (ring), 4 (pinky).
- F#4/G $\flat$ 4:** Treble clef, one sharp and one flat. Fingering: 1 (index), 2 (middle), 3 (ring), 4 (pinky).

G4                      G#4/A,4                      A4

This section shows three chords: G4, G#4/A,4, and A4. Each chord is represented by a treble clef staff with a single note and a corresponding fretboard diagram. The fretboard diagrams are vertical rectangles with six circles representing strings. Black circles indicate fretted notes, and white circles indicate open strings. G4 is a single G note on the 2nd fret of the 3rd string. G#4/A,4 is a G# note on the 4th fret of the 3rd string and an A note on the 2nd fret of the 4th string. A4 is a single A note on the 2nd fret of the 4th string.

A#4/B,4                      B4                      C5

This section shows three chords: A#4/B,4, B4, and C5. Each chord is represented by a treble clef staff with a single note and a corresponding fretboard diagram. The fretboard diagrams are vertical rectangles with six circles representing strings. Black circles indicate fretted notes, and white circles indicate open strings. A#4/B,4 is an A# note on the 4th fret of the 3rd string and a B note on the 2nd fret of the 4th string. B4 is a single B note on the 2nd fret of the 4th string. C5 is a single C note on the 1st fret of the 5th string.

C#5/D,5

This section shows the chord C#5/D,5. It is represented by a treble clef staff with a single note and a corresponding fretboard diagram. The fretboard diagram is a vertical rectangle with six circles representing strings. Black circles indicate fretted notes, and white circles indicate open strings. C#5/D,5 is a C# note on the 4th fret of the 3rd string and a D note on the 2nd fret of the 4th string.

# MEMO



## Roland Service Centers and Distributors

When you need repair service, access this URL and find your nearest Roland Service Center or authorized Roland distributor in your country.

<http://roland.cm/service>



 **Roland**