



ProFXv3 Series Mixers

ProFX6v3 • ProFX10v3 • ProFX12v3

ProFX16v3 • ProFX22v3 • ProFX30v3

Mackie ProFXv3 Series Effects Mixers with USB are the ultimate affordable solution for live sound, home recording, and content creators available in 6, 10, 12, 16, 22, and 30 channels.

Now with our renowned Onyx™ mic preamps that offer 60 dB of headroom, everything from gain hungry mics to guitars will sound better than ever. And you can keep it all in check with easy single-knob compression.

The new GigFX™ effects engine offers 24 built-in FX for even more options for adding the finishing touch.

Record your tracks in 24-Bit/192kHz quality with 2x4 USB I/O with zero-latency hardware monitoring for easy overdubs. Both ProTools® | First and Waveform™ OEM recording software/plugin packages are included.

APPLICATIONS:

Live sound mixing, houses of worship, clubs, gymnasiums, banquet halls, conference rooms, boardrooms, studio and field recording, video post-production, multimedia applications, broadcast, and many, many more.



Like us



Follow us



Watch our dang videos

FEATURES:

■ Mix / Record / Create

- We've taken our most popular mixer series and given it major upgrades that will take your sound quality to the next level
- Perfect for live sound, home recording, content creation, and live streaming
- With models available in 6, 10, 12, 16, 22, and 30 channels, you can get the perfect mixer for your application or go big and be ready when the need comes

■ Renowned Onyx Mic Preamps

- With up to 60 dB of gain and ultra-low noise, ProFXv3 mixers allow you to sound better than ever
- Perfect for microphones popular with content creators that require high-gain preamps

■ High-Resolution GigFX™ Effects Engine

- With 24 different FX options, from reverbs to delays, adding some drama to your sound is easy easy... easy..... easy..... easy (Delay, get it?)

■ 24-Bit / 192kHz 2x4 USB Recording Interface

- Lay down your tracks in incredible 24-Bit / 192kHz quality for the cleanest recordings possible
- 2x4 USB I/O allows you to create two custom mixes on your computer to send back into your ProFXv3 mixer, great for situations when you need to monitor specific tracks during playback in addition to the full mix

■ Effortless Latency-Free Monitoring

- With a single knob, you can blend between monitoring your computer's output and a direct feed from the mixer
- Great for recording overdubs alongside a pre-recorded track

■ Single-Knob Compression *

- Keep your input levels in check and get maximum channel headroom with the quick turn of a knob
- Great for giving vocals the finishing touch in live, recording, and even streaming applications

■ Record and Produce Like a Pro

- ProTools® | First and Waveform™ OEM professional software and plugin packages included
- The Musician Collection for ProTools | First includes 23 plugins like BBD Delay, Eleven Lite, 304 EQ, and 304C Compressor
- The DAW Essentials™ Bundle for Waveform™ OEM includes 16 powerful plugins like Equaliser, Compressor, Reverber8, and Limiter

■ Signature Rugged Design

- Legendary Built-Like-A-Tank™ design
- Solid steel chassis protects your investment
- Tough ABS side protection

■ Accessories

- Protective dust cover (sold separately) *
- Protective bag (sold separately) **

* Not available for ProFX6v3

** Not available for ProFX30v3

PROFX3 SPECIFICATIONS

Noise Characteristics

Equivalent Input Noise (EIN) (150 Ω Source Impedance, 20 Hz to 20 kHz)	
Mic in to Insert Send out, max gain	-126 dBu ¹ -128 dBu ²
Residual Output Noise	
All outputs, master levels off, all channel levels off	-95 dBu
All outputs, master levels unity, one channel level unity	-80 dBu ¹ -85 dBu ²

Frequency Response

Mic input to any output (gain at unity, +0 dB / -1 dB) 20 Hz to 30 kHz

Distortion

(22 Hz to 80 kHz bandwidth)	
Mic in to Main Out (+4 dBu output)	<0.03% ¹ <0.01% ²

Attenuation and Crosstalk

Adjacent Inputs @1 kHz	-90 dB
Inputs to Outputs @1 kHz	-80 dB
Fader Off @1 kHz	-75 dB
Mute Switch / Break Switch Mute @ 1 kHz	-90 dB ¹ -100 dB ²

Common Mode Rejection Ratio (CMRR)

Mic in to Main out, max gain, 1 kHz	70 dB
-------------------------------------	-------

Maximum Levels

All inputs	+22 dBu
Main Mix XLR	+28 dBu
All other outputs	+22 dBu

Impedances

Mic in	3.3 kΩ
Channel Insert Return	10 kΩ
All other inputs	≥20 kΩ
Phones out	25 Ω
All other outputs	120 Ω Unbalanced, 240 Ω Balanced

Equalization

ProFX6v3	
Low	±15 dB @ 80 Hz
High	±15 dB @ 12 kHz
Low Cut Filter	18 dB/octave @ 100 Hz
ProFX10v3 • ProFX12v3	
Low	±15 dB @ 80 Hz
Mid	±15 dB @ 2.5 kHz
High	±15 dB @ 12 kHz
Low Cut Filter	18 dB/octave @ 100 Hz
ProFX16v3 • ProFX22v3 • ProFX30v3 All Channels (except 1/8" stereo channel)	
Low	±15 dB @ 80 Hz
Mid	±15 dB @ 100 Hz - 8 kHz
High	±15 dB @ 12 kHz
Low Cut Filter	18 dB/octave @ 100 Hz
1/8" Stereo Channel	
Low	±15 dB @ 80 Hz
Mid	±15 dB @ 2.5 kHz
High	±15 dB @ 12 kHz

Maximum Voltage Gain (EQ Flat)

Mic Input Channel to	
Insert Output	60 dB
1/4" Main Output	80 dB
XLR Main Output	86 dB
1/4" Sub Output	80 dB
Aux Output (Pre-Fader)	80 dB
Aux Output (Post-Fader)	90 dB
FX Send	90 dB
FX Send [ProFX10v3]	80 dB
USB Output	70 dB
Mono Line Input Channel to	
Insert Output	40 dB
1/4" Main Output	60 dB
XLR Main Output	66 dB
1/4" Sub Output	60 dB
Aux Output (Pre-Fader)	60 dB
Aux Output (Post-Fader)	70 dB
FX Send	70 dB
FX Send [ProFX10v3]	60 dB
USB Output	50 dB
Stereo Line Input Channel to	
1/4" Main Output	20 dB
XLR Main Output	26 dB
1/4" Sub Output	20 dB
Aux Output (Pre-Fader)	20 dB
Aux Output (Post-Fader)	30 dB
FX Send	30 dB
FX Send [ProFX10v3]	20 dB
USB Output	10 dB

¹ ProFX6v3, ProFX10v3, ProFX12v3

² ProFX16v3, ProFX22v3, ProFX30v3

PROFX3 SPECIFICATIONS CONTINUED...

1/8" Input to	
1/4" Main Output	40 dB
XLR Main Output	46 dB
1/4" Sub Output	40 dB
Aux Output (Pre-Fader)	40 dB
Aux Output (Post-Fader)	50 dB
FX Send	50 dB
FX Send [ProFX10v3]	40 dB
USB Output	30 dB
<hr/>	
USB Input to	
XLR Main Output	46 dB

Digital Effects

Number of Presets	24
-------------------	----

Meters

Main L/R Mix	
ProFX6v3 – Two columns of 8 segments each:	
OL, +14, +8, +4, 0 (0 dBu), -4, -12, -24	
All other ProFXv3 mixers – Two columns of 12 segments each:	
OL, +15, +10, +6, +3, 0 (0 dBu), -2, -4, -7, -10, -20, -30	

USB

Format	USB 2.0
I/O	1 Stereo Input, 2 Stereo Outputs
A/D/A	24 bit, 44.1 kHz, 48 kHz, 96 kHz, 192 kHz

Phantom Power

48 VDC to all Mic channels simultaneously	
-------------------------------------------	--

AC Power Requirements

Power Consumption	30 watts (ProFX12v3) 40 watts (ProFX16v3) 45 watts (ProFX22v3) 50 watts (ProFX30v3)
Universal AC Power Supply	100 – 240 VAC, 50 – 60 Hz
Power Connector	
ProFX6v3, ProFX10v3	12VDC @ 2A Class I Hard-Wired Wall Mount Adapter
ProFX12v3, ProFX16v3, ProFX22v3, ProFX30v3	3-Pin IEC Line Cord

Physical Properties (product)

ProFX6v3:	
Height:	2.9 in / 74 mm
Width:	7.5 in / 191 mm
Depth:	8.4 in / 213 mm
Weight:	2.6 lb / 1.2 kg

ProFX10v3:	
Height:	3.3 in / 84 mm
Width:	10.7 in / 272 mm
Depth:	11.9 in / 302 mm
Weight:	4.9 lb / 2.2 kg

ProFX12v3:	
Height:	4.0 in / 102 mm
Width:	13.0 in / 330 mm
Depth:	14.8 in / 376 mm
Weight:	7.9 lb / 3.6 kg

ProFX16v3:	
Height:	4.4 in / 112 mm
Width:	17.7 in / 450 mm
Depth:	17.1 in / 434 mm
Weight:	15.2 lb / 6.9 kg

ProFX22v3:	
Height:	4.4 in / 112 mm
Width:	24.1 in / 612 mm
Depth:	17.1 in / 434 mm
Weight:	19.8 lb / 9.0 kg

ProFX30v3:	
Height:	4.4 in / 112 mm
Width:	32.3 in / 820 mm
Depth:	17.1 in / 434 mm
Weight:	26.5 lb / 12.0 kg

PROFX3 SPECIFICATIONS CONTINUED...
Physical Properties (packaged product)
ProFX6v3:

Height:	4.3 in / 109 mm
Width:	12.2 in / 310 mm
Depth:	9.5 in / 241 mm
Weight:	4.0 lb / 0.5 kg

ProFX10v3:

Height:	4.3 in / 109 mm
Width:	12.9 in / 328 mm
Depth:	15.0 in / 381 mm
Weight:	6.4 lb / 2.9 kg

ProFX12v3:

Height:	5.7 in / 145 mm
Width:	15.6 in / 396 mm
Depth:	18.2 in / 462 mm
Weight:	11.2 lb / 5.1 kg

ProFX16v3:

Height:	8.2 in / 208 mm
Width:	20.4 in / 518 mm
Depth:	21.6 in / 549 mm
Weight:	20.1 lb / 9.1 kg

ProFX22v3:

Height:	8.5 in / 216 mm
Width:	28.0 in / 711 mm
Depth:	21.8 in / 554 mm
Weight:	24.9 lb / 11.3 kg

ProFX30v3:

Height:	8.7 in / 221 mm
Width:	37.8 in / 960 mm
Depth:	21.9 in / 556 mm
Weight:	32.2 lb / 14.6 kg

Options

ProFX6v3 Carry Bag	P/N 2051719
ProFX10v3 Carry Bag	P/N 2051720
ProFX10v3 Dust Cover	P/N 2051726
ProFX12v3 Carry Bag	P/N 2051721
ProFX12v3 Dust Cover	P/N 2051727
ProFX12v3 Rack Ear Kit	P/N 2051623
ProFX16v3 Carry Bag	P/N 2051722
ProFX16v3 Dust Cover	P/N 2051728
ProFX16v3 Rack Ear Kit	P/N 2051634
ProFX22v3 Carry Bag	P/N 2051723
ProFX22v3 Dust Cover	P/N 2051729
ProFX30v3 Dust Cover	P/N 2051730

Ordering Information
ProFX6v3 6 Channel Professional Effects Mixer with USB

	P/N 2051741-00 (US)
	P/N 2051299-01 (EU)
	P/N 2051299-02 (JP)
	P/N 2051299-03 (UK)
	P/N 2051299-04 (AU)
	P/N 2051299-05 (CN)
	P/N 2051299-07 (AR)
	P/N 2051299-08 (KR)

ProFX10v3 10 Channel Professional Effects Mixer with USB

	P/N 2051742-00 (US)
	P/N 2051300-01 (EU)
	P/N 2051300-02 (JP)
	P/N 2051300-03 (UK)
	P/N 2051300-04 (AU)
	P/N 2051300-05 (CN)
	P/N 2051300-07 (AR)
	P/N 2051300-08 (KR)

ProFX12v3 12 Channel Professional Effects Mixer with USB

	P/N 2051743-00 (US)
	P/N 2051301-01 (EU)
	P/N 2051301-03 (UK)
	P/N 2051301-05 (CN)



PROFXV3 SPECIFICATIONS CONTINUED...

ProFX16v3 16 Channel 4-Bus Professional Effects Mixer with USB

P/N 2051744-00 (US)
P/N 2051302-01 (EU)
P/N 2051302-03 (UK)
P/N 2051302-05 (CN)

ProFX22v3 22 Channel 4-Bus Professional Effects Mixer with USB

P/N 2051745-00 (US)
P/N 2051303-01 (EU)
P/N 2051303-03 (UK)
P/N 2051303-05 (CN)

ProFX30v3 30 Channel 4-Bus Professional Effects Mixer with USB

P/N 2051746-00 (US)
P/N 2051304-01 (EU)
P/N 2051304-03 (UK)
P/N 2051304-05 (CN)

PROFX6V3 DIMENSIONS

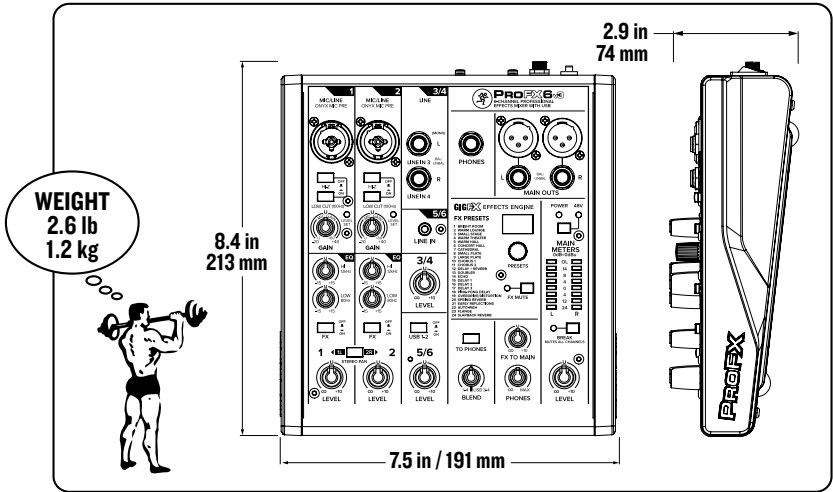

PROFX10V3 DIMENSIONS

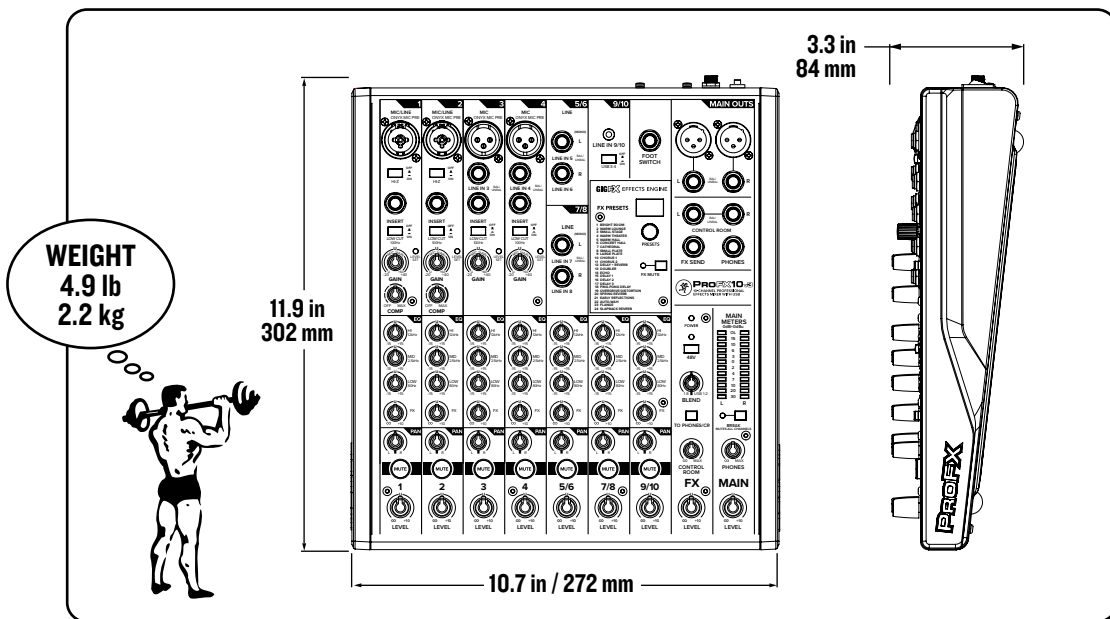

PROFX12V3 DIMENSIONS

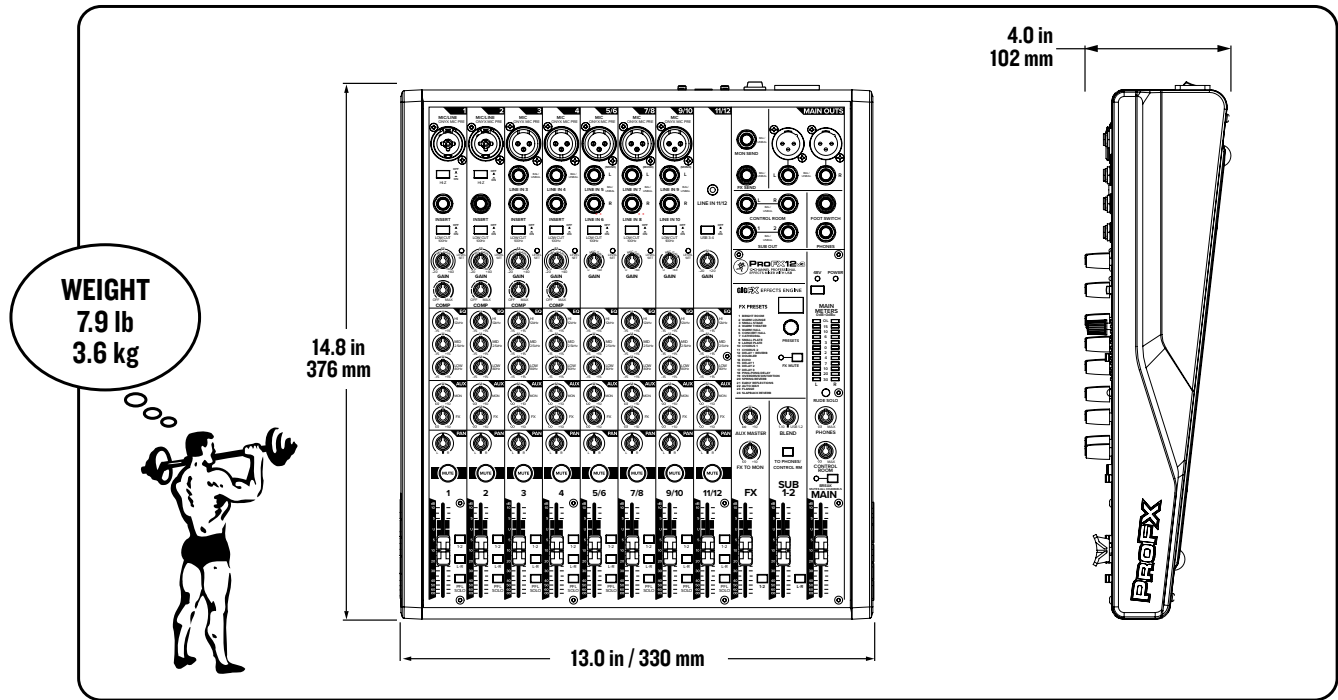

PROFX16V3 DIMENSIONS

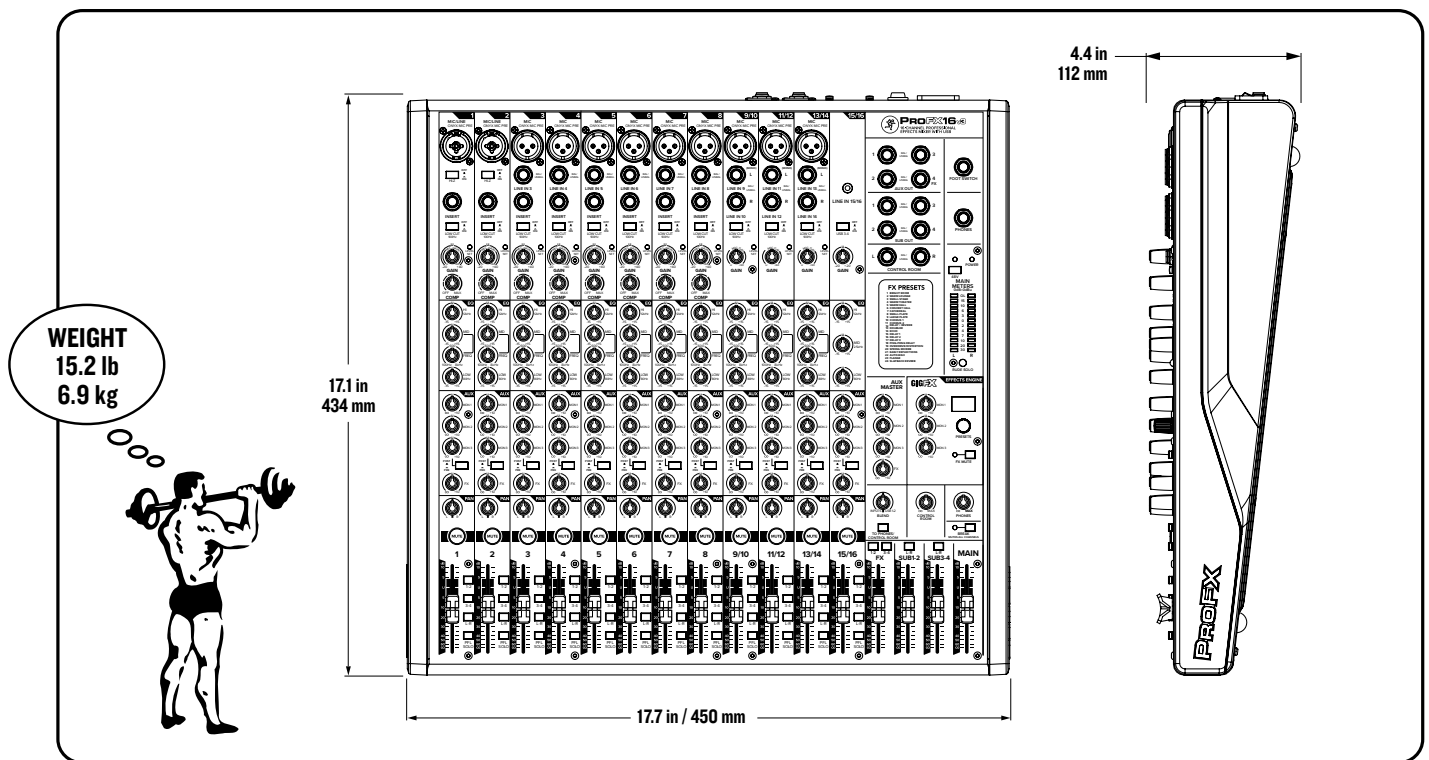

PROFX22V3 DIMENSIONS

WEIGHT
19.8 lb
9.0 kg



17.1 in
434 mm

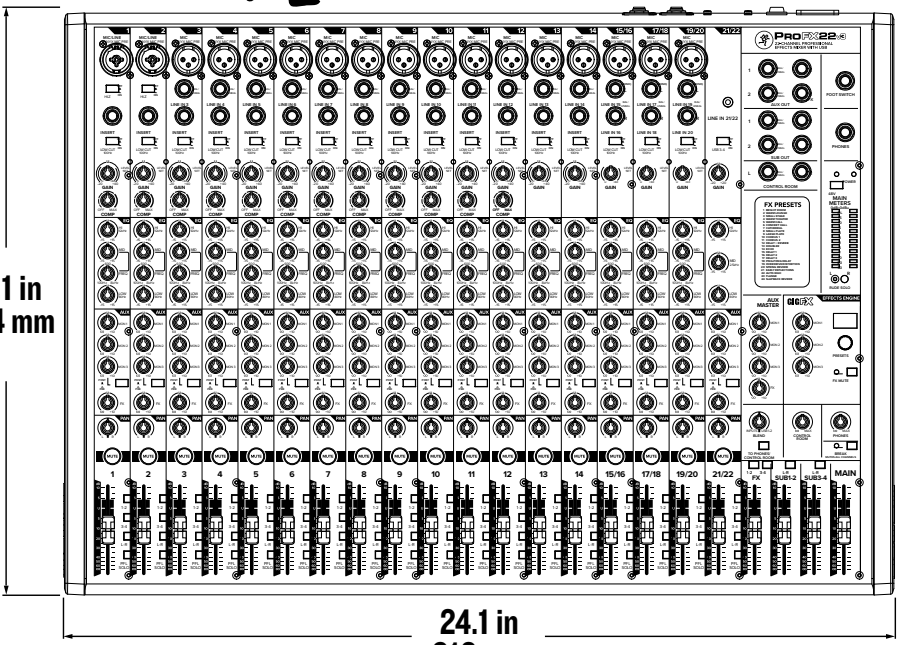

24.1 in
612 mm

4.4 in
112 mm

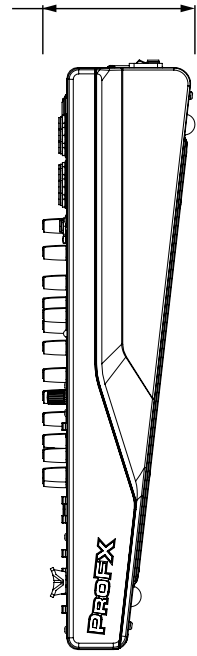



PROFX^{v3} SERIES

PROFESSIONAL EFFECTS MIXERS WITH USB

PROFX30V3 DIMENSIONS

WEIGHT
26.5 lb
12.0 kg

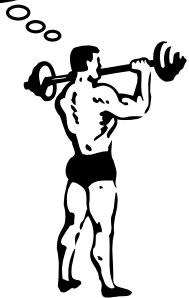

4.4 in
112 mm

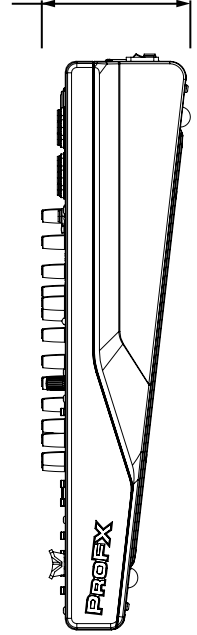

17.1 in
434 mm

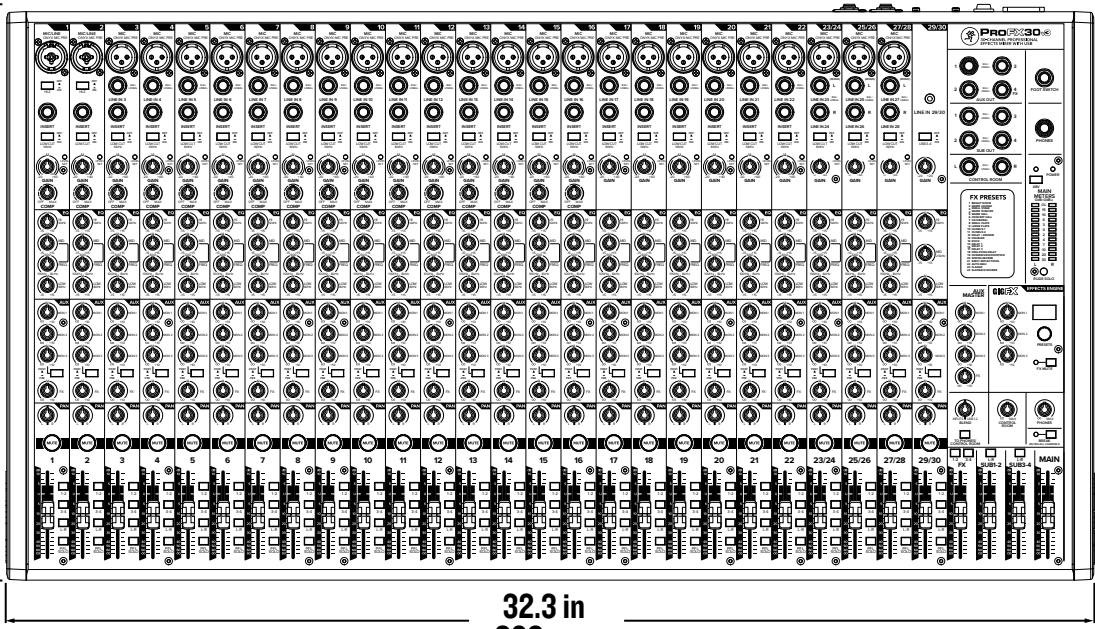

32.3 in
820 mm

PROFX6V3 BLOCK DIAGRAM

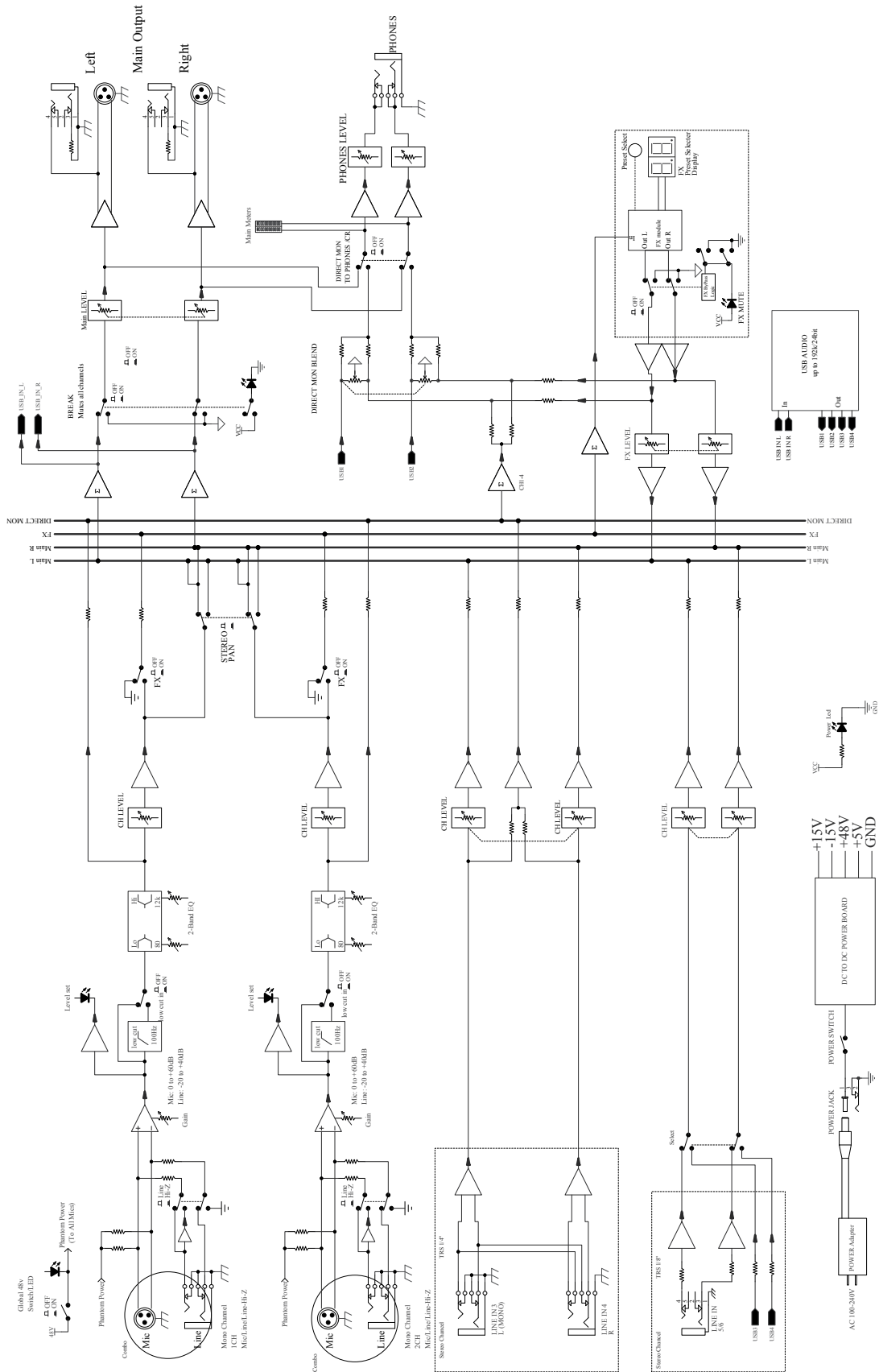

Note: Switch are shown in the default (out) position

PROFX10V3 BLOCK DIAGRAM

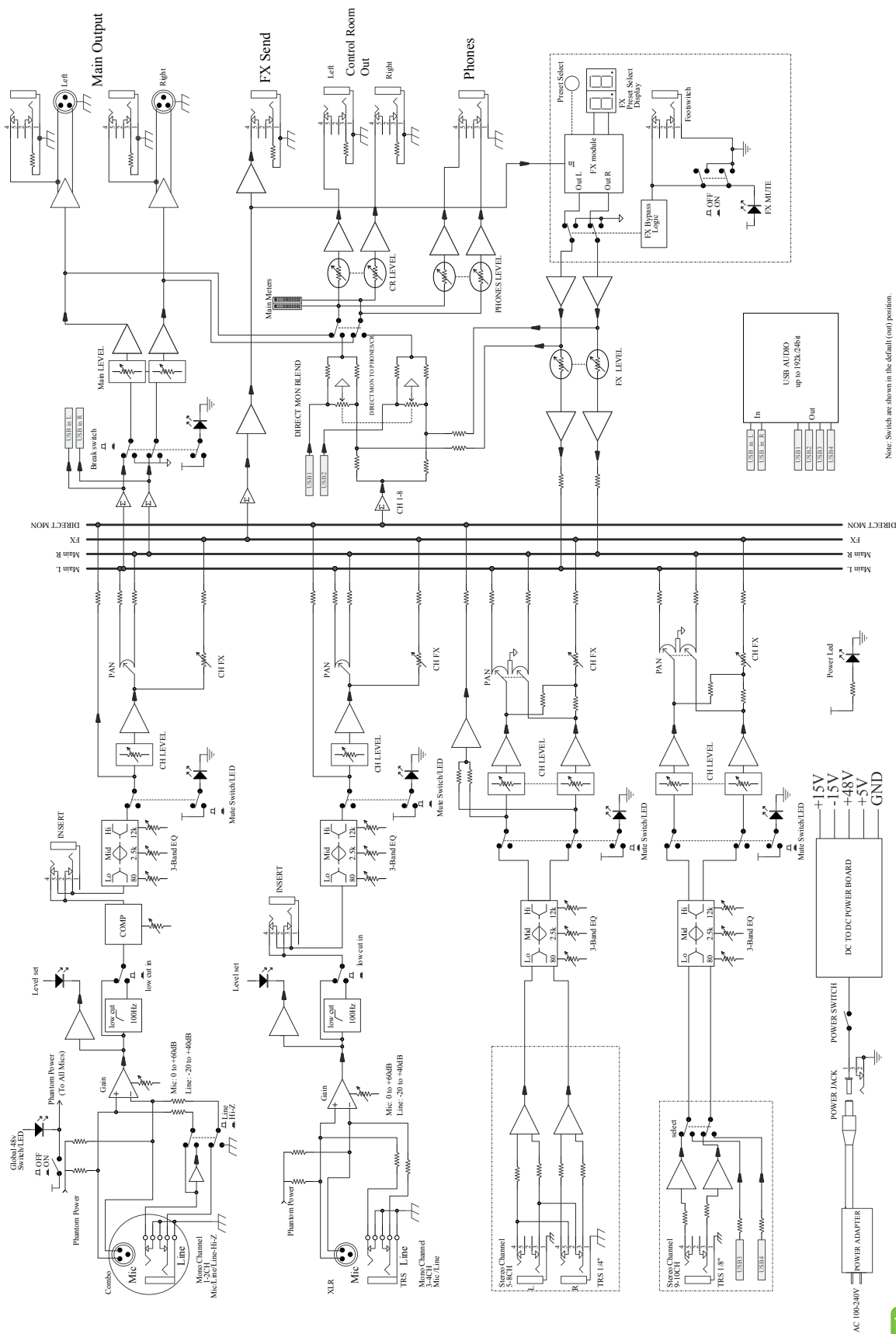

Note: Switches are shown in the default (out) position.

PROFX12V3 BLOCK DIAGRAM

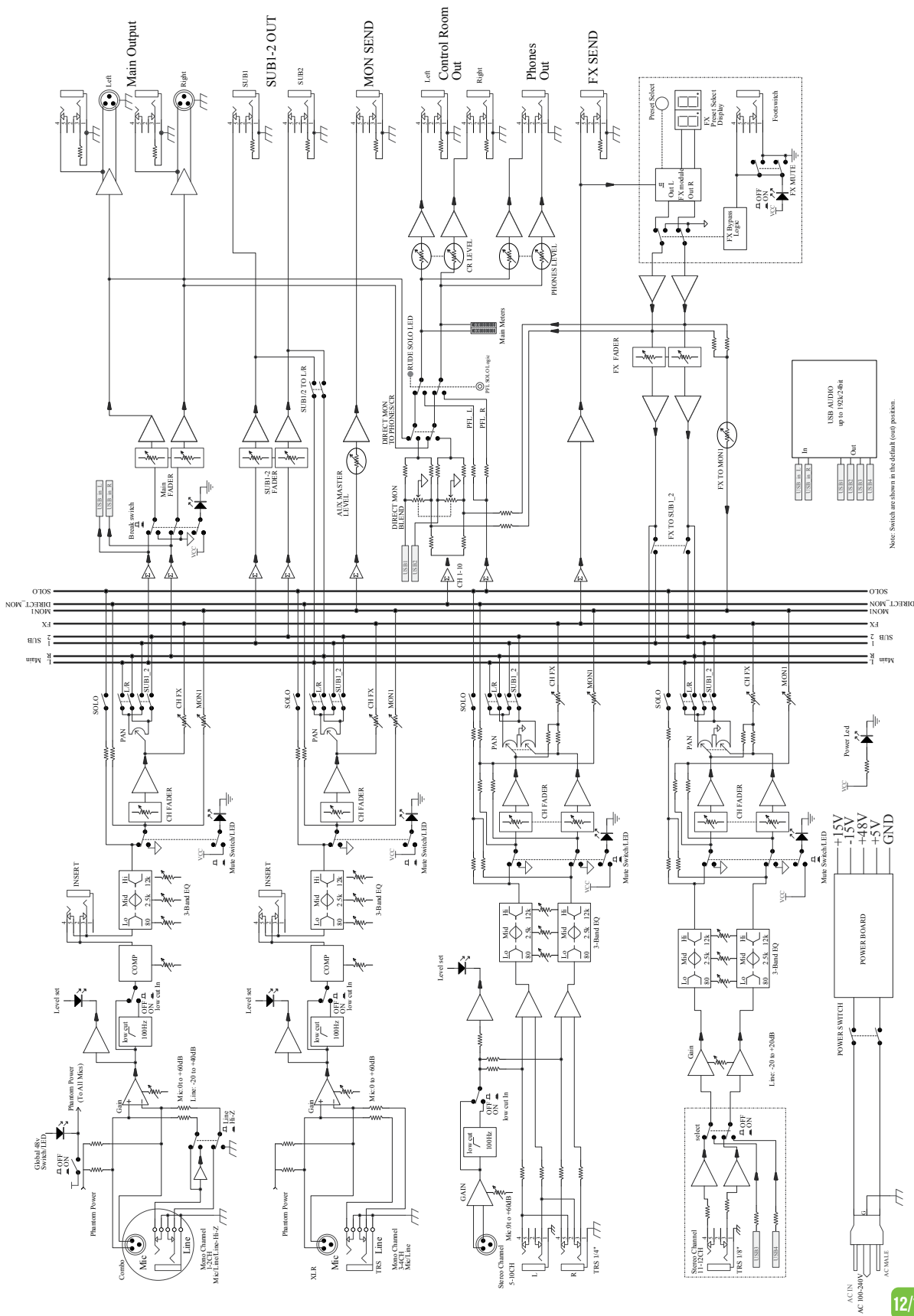

PROFX16V3 • PROFX22V3 • PROFX30V3 BLOCK DIAGRAM

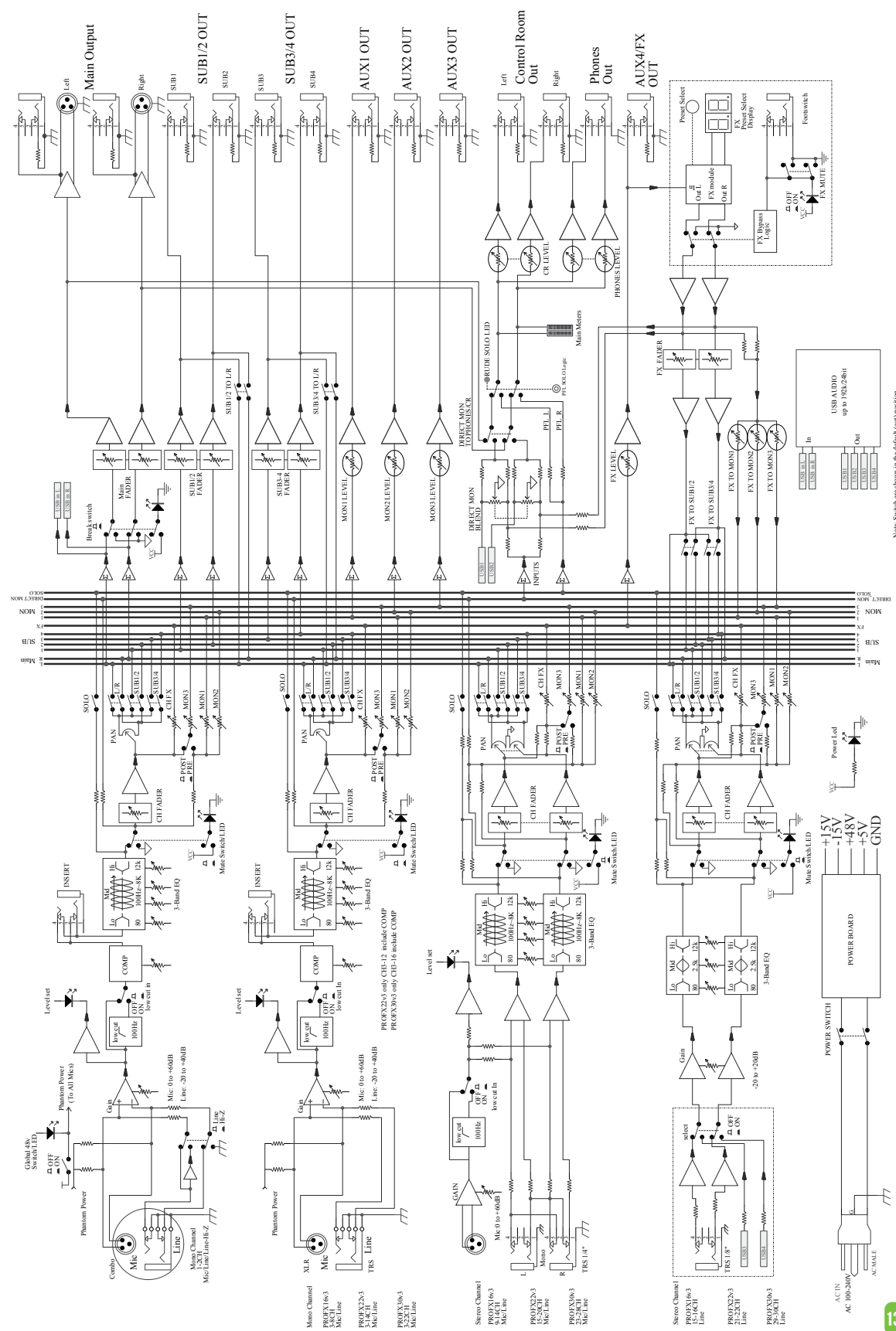

Note: Switch are shown in the default (comp) position.



PROFX_{v3} SERIES

PROFESSIONAL EFFECTS MIXERS WITH USB



www.mackie.com
19820 North Creek Parkway #201
Bothell, WA 98011 USA
800-898-3211, Fax 425-487-4337

Part No. SW1287 Rev. B 02/20

Electronic files for this product are available at:
www.mackie.com

Specification Sheet	ProFXv3_SS.PDF
Owner's Manual	ProFXv3_OM.PDF

LOUD Audio, LLC. is always striving to improve our products by incorporating new and improved materials, components, and manufacturing methods. Therefore, we reserve the right to change these specifications at any time without notice.

"Mackie" and the "Running Man" figure are registered trademarks of LOUD Audio, LLC. All other brands mentioned are trademarks or registered trademarks of their respective holders, and are hereby acknowledged.

©2020 LOUD Audio, LLC. All rights reserved.

14/14 PAGES